

RACCORDI PER SALDATURA DI TESTA

Serie di raccordi destinati al convogliamento di fluidi in pressione con sistema di giunzione mediante saldatura di testa.

RACCORDI SERIE METRICA ISO-UNI

Specifiche tecniche	
Gamma dimensionale	d 20 ÷ d 400 (mm)
Pressione nominale	SDR 17,6 (PN6) con acqua a 20 °C SDR 11 (PN10) con acqua a 20 °C
Campo di temperatura	0 °C ÷ 100 °C
Standard di accoppiamento	Saldatura: EN ISO 15494. Accoppiabili con tubi secondo EN ISO 15494 Flangiatura: ISO 7005-1, EN 1092-1, EN ISO 15494, DIN 2501, ANSI B16.5 cl.150
Riferimenti normativi	Criteri Costruttivi: EN ISO 15494 Metodi e requisiti dei test: EN ISO 15494 Criteri di installazione: DVS 2202-1, DVS 2207-11, DVS 2208-1, UNI 11397
Materiale raccordi	PP-H
Materiali tenuta	EPDM, FPM

DATI TECNICI

VARIAZIONE DELLA PRESSIONE IN FUNZIONE DELLA TEMPERATURA

Per acqua o fluidi non pericolosi nei confronti dei quali il materiale è classificato CHIMICAMENTE RESISTENTE. In altri casi è richiesta un'adeguata diminuzione della pressione nominale PN.

A = SDR 11 ISO-S5 - 5 anni

B = SDR 11 ISO-S5 - 25 anni

C = SDR 17,6 ISO-S8,3 - 5 anni

D = SDR 17,6 ISO-S8,3 - 25 anni

Pressioni effettive di servizio ammissibili per raccordi di testa in PP-H in accordo a DIN 16962.

Coefficiente di sicurezza=1.7

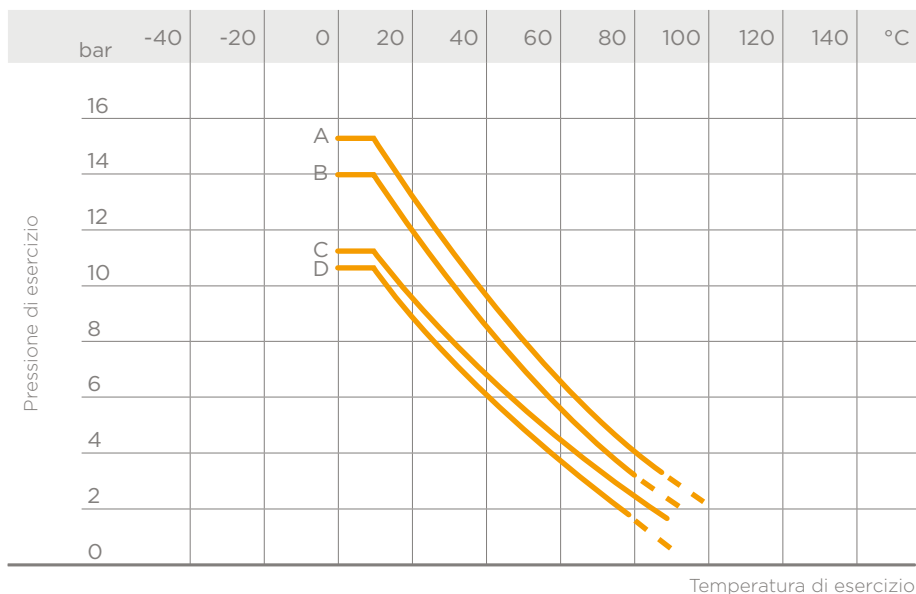

VARIAZIONE DELLA PRESSIONE IN FUNZIONE DELLA TEMPERATURA

Per acqua o fluidi non pericolosi nei confronti dei quali il materiale è classificato CHIMICAMENTE RESISTENTE. In altri casi è richiesta un'adeguata diminuzione della pressione nominale PN.

E = SDR 11 ISO-S5 - 10 anni

F = SDR 11 ISO-S5 - 50 anni

G = SDR 17,6 ISO-S8,3 - 10 anni

H = SDR 17,6 ISO-S8,3 - 50 anni

Pressioni effettive di servizio ammissibili per raccordi di testa in accordo a DIN 16962 e per tubazioni in PP-H in accordo a DIN 8077.

Coefficiente di sicurezza=1.7

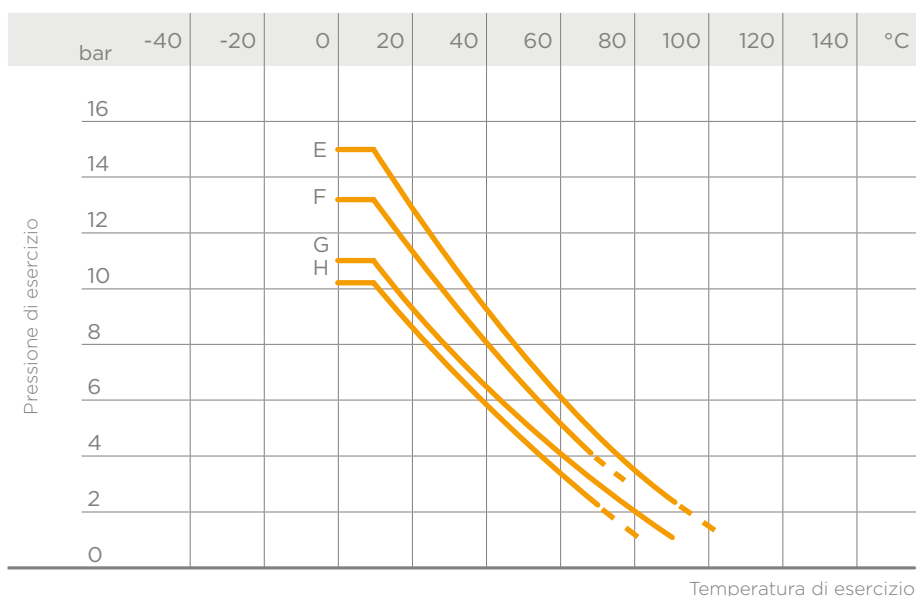

DIMENSIONI

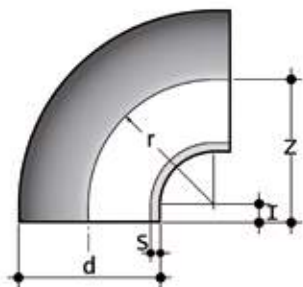

GBM

Curva a 90° codolo corto per saldatura di testa

d	l	r	Z	SDR 17,6 - S 8,3		SDR 11 - S 5		Codice SDR 17,6 - S 8,3	Codice SDR 11 - S 5
				s	g	s	g		
20	3	24	27	-	-	1,9	5	-	GBM11020
25	5	27	32	-	-	2,3	9	-	GBM11025
32	5	35	40	-	-	2,9	17	-	GBM11032
40	7	44	51	2,3	27	3,7	36	GBM17040	GBM11040
50	7	55	62	2,9	47	4,6	66	GBM17050	GBM11050
63	8	69	77	3,6	89	5,8	124	GBM17063	GBM11063
75	10	75	85	4,3	152	6,8	210	GBM17075	GBM11075
90	10	90	100	5,1	245	8,2	355	GBM17090	GBM11090
110	10	110	120	6,3	422	10	616	GBM17110	GBM11110
125	15	125	140	7,1	652	11,4	945	GBM17125	GBM11125
140	15	140	155	8	900	12,7	1300	GBM17140	GBM11140
160	15	160	175	9,1	1231	14,6	1870	GBM17160	GBM11160
180	15	180	195	10,2	1875	16,4	2767	GBM17180	GBM11180
200	15	200	215	11,4	2423	18,2	3604	GBM17200	GBM11200
225	20	225	245	12,8	3469	20,5	5292	GBM17225	GBM11225
250	25	250	275	14,2	4568	22,7	7210	GBM17250	GBM11250
280	30	280	310	15,9	6550	25,4	10020	GBM17280	GBM11280
315	35	315	350	17,9	9728	28,6	13965	GBM17315	GBM11315
355	40	300	340	21,1	11320	32,2	17040	GBM17355	GBM11355
400	49	300	349	23,7	14580	36,3	21980	GBM17400	GBM11400

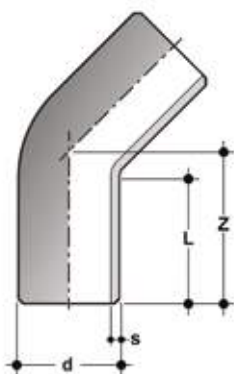

HBM

Curva a 45° codolo lungo per saldatura di testa

d	L	Z	SDR 17,6 - S 8,3		L	Z	s	SDR 11 - S 5		Codice SDR 17,6 - S 8,3	Codice SDR 11 - S 5
			s	g				g	g		
20	-	-	-	-	39	44	1,9	10	-	HBM11020	
25	-	-	-	-	42	48	2,3	16	-	HBM11025	
32	-	-	-	-	49	57	2,9	33	-	HBM11032	
40	-	-	-	-	53	63	3,7	51	-	HBM11040	
50	-	-	-	-	57	70	4,6	91	-	HBM11050	
63	66	80	3,8	110	67	80	5,8	169	HBM17063	HBM11063	
75	70	90	4,5	175	72,5	90	6,8	259	HBM17075	HBM11075	
90	79	101	5,4	291	82	104	8,2	422	HBM17090	HBM11090	
110	82	112	6,6	481	85	114	10	668	HBM17110	HBM11110	
125	99,5	130,5	7,4	670	99,5	132,5	11,4	1015	HBM17125	HBM11125	
140	102	137	8,3	847	100	136	12,7	1340	HBM17140	HBM11140	
160	116,5	156,5	9,5	1280	116,5	156,5	14,6	1960	HBM17160	HBM11160	
180	133,5	178,5	10,7	1960	131,5	176,5	16,4	2780	HBM17180	HBM11180	
200	122,5	166	11,9	2200	120,5	170,5	18,2	3440	HBM17200	HBM11200	
225	128	184	13,4	3040	128	182,5	20,5	4660	HBM17225	HBM11225	
250	160	217	14,8	4580	160	217	22,7	6760	HBM17250	HBM11250	
280	175	232	16,6	6200	173	243	25,4	8940	HBM17280	HBM11280	
315	180	251	18,7	8320	179	256	28,6	12260	HBM17315	HBM11315	

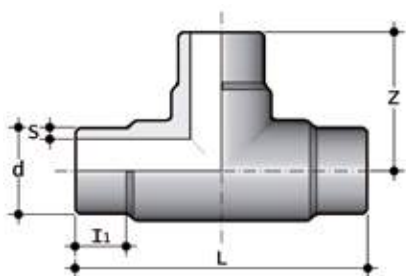

TBM

Ti a 90° codolo corto per saldatura di testa

d	l ₁	L	Z	SDR 17,6 - S 8,3		SDR 11 - S 5		Codice SDR 17,6 - S8,3	Codice SDR 11 - S5
				s	g	s	g		
20	8	50	25	-	-	1,9	11	-	TBM11020
25	10	60	30	-	-	2,3	15	-	TBM11025
32	12	80	40	-	-	2,9	30	-	TBM11032
40	16	88	44	2,3	40	3,7	55	TBM17040	TBM11040
50	21	116	58	2,9	80	4,6	115	TBM17050	TBM11050
63	24	146	73	3,6	175	5,8	230	TBM17063	TBM11063
75	28	170	85	4,3	295	6,8	390	TBM17075	TBM11075
90	23	200	100	5,1	480	8,2	645	TBM17090	TBM11090
110	43	240	120	6,3	790	10	1040	TBM17110	TBM11110
125	26	250	125	7,1	1150	11,4	1480	TBM17125	TBM11125
140	32	280	140	8	1455	12,7	2060	TBM17140	TBM11140
160	40	320	160	9,1	2170	14,6	2925	TBM17160	TBM11160
180	73	390	195	10,2	3315	16,4	4665	TBM17180	TBM11180
200	64	430	215	11,4	4600	18,2	6470	TBM17200	TBM11200
225	72	490	245	12,8	6530	20,5	9220	TBM17225	TBM11225
250	86	550	275	14,2	8145	22,7	12650	TBM17250	TBM11250
280	105	620	310	15,9	13000	25,4	18205	TBM17280	TBM11280
315	111	700	350	17,9	18375	28,6	25700	TBM17315	TBM11315
355	105	690	345	21,1	19700	32,2	30620	TBM17355	TBM11355
400	103	700	355	23,7	27740	36,3	38760	TBM17400	TBM11400

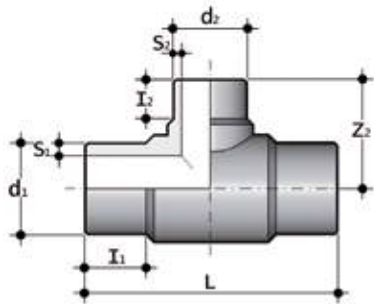

TRBM

Ti a 90° ridotto codolo corto per saldatura di testa

d ₁	d ₂	SDR 17,6 - S 8,3								SDR 11 - S 5							Codice SDR 17,6 - S 8,3	Codice SDR 11 - S 5
		l ₁	l ₂	L	s ₁	s ₂	Z ₂	g	l ₁	l ₂	L	s ₁	s ₂	Z ₂	g			
*63	50	63	56	220	3,8	3	103	210	63	56	220	5,8	4,6	103	300	TRBM17063050	TRBM11063050	
*75	32	-	-	-	-	-	-	-	70	46	256	6,8	2,9	103	500	-	TRBM11075032	
*75	50	70	55	253	4,5	3	113	410	70	56	253	6,8	4,6	113	510	TRBM17075050	TRBM11075050	
*75	63	70	63	260	4,5	3,8	117	420	70	63	260	6,8	5,8	117	430	TRBM17075063	TRBM11075063	
90	32	-	-	-	-	-	-	-	53	23	213	8,2	2,9	85	560	-	TRBM11090032	
90	50	-	-	-	-	-	-	-	53	28	213	8,2	4,6	100	580	-	TRBM11090050	
*90	63	79	63	275	5,4	3,8	137	570	79	64	272	8,2	5,8	139	780	TRBM17090063	TRBM11090063	
*90	75	74	70	278	5,4	4,5	138	570	73	68	272	8,2	6,8	138	790	TRBM17090075	TRBM11090075	
110	32	-	-	-	-	-	-	-	66	22	244	10	2,9	94	920	-	TRBM11110032	
110	50	-	-	-	-	-	-	-	66	27	244	10	4,6	103	1000	-	TRBM11110050	
*110	63	85	66	315	6,6	3,8	159	960	87	65	315	10	5,8	159	1210	TRBM17110063	TRBM11110063	
*110	75	82	70	315	6,6	4,5	157	850	87	65	315	10	6,8	157	1180	TRBM17110075	TRBM11110075	
*110	90	82	79	315	6,6	5,4	155	900	84	79	315	10	8,2	155	1240	TRBM17110090	TRBM11110090	
125	63	70	31	271	7,4	3,8	112	1030	70	31	278	11,4	5,8	112	1360	TRBM17125063	TRBM11125063	
*125	90	-	-	-	-	-	-	-	112	92	340	11,4	8,2	170	1640	-	TRBM11125090	
*125	110	87	82	340	7,4	6,6	170	1240	90	83	340	11,4	10	169	1860	TRBM17125110	TRBM11125110	
140	63	83	32	300	8,3	3,8	120	1310	83	32	305	12,7	5,8	120	1760	TRBM17140063	TRBM11140063	
140	75	81	35	300	8,3	4,5	130	1400	81	35	305	12,7	6,8	130	2020	TRBM17140075	TRBM11140075	
140	90	81	41	300	8,3	5,4	130	1380	81	41	305	12,7	8,2	130	1840	TRBM17140090	TRBM11140090	
140	110	50	47	300	8,3	6,6	137	1640	50	47	305	12,7	10	141	2200	TRBM17140110	TRBM11140110	
*160	63	98	64	347	9,5	3,8	175	1850	100	67	347	14,6	5,8	175	2640	TRBM17160063	TRBM11160063	
*160	75	98	75	348	9,5	4,5	179	1910	101	76	348	14,6	6,8	180	2600	TRBM17160075	TRBM11160075	
*160	90	100	81	349	9,5	5,4	182	1940	101	80	349	14,6	8,2	182	2640	TRBM17160090	TRBM11160090	
*160	110	98	85	400	9,5	6,6	202	2360	98	83	400	14,6	10	202	3220	TRBM17160110	TRBM11160110	
160	125	58	47	315	9,5	7,4	150	2040	59	48	325	14,6	11,4	150	2730	TRBM17160125	TRBM11160125	
180	63	125	30	358	10,7	3,8	134	2060	125	30	358	16,4	5,8	134	3040	TRBM17180063	TRBM11180063	
180	75	112	30	360	10,7	4,5	140	2100	112	30	352	16,4	6,8	140	3020	TRBM17180075	TRBM11180075	
*180	90	134	97	420	10,7	5,4	200	2800	136	95	395	16,4	8,2	202	4240	TRBM17180090	TRBM11180090	
180	110	106	48	365	10,7	6,6	158	2160	-	-	-	-	-	-	-	TRBM17180110	-	
*180	110	-	-	-	-	-	-	-	140	98	395	16,4	10	210	4580	-	TRBM11180110	
180	125	92	50	358	10,7	7,4	156	2240	96	101	366	16,4	11,4	166	3240	TRBM17180125	TRBM11180125	
*180	160	105	91	412	10,7	9,5	204	3070	105	94	411	16,4	14,6	205	4390	TRBM17180160	TRBM11180160	
*200	63	134	80	550	11,9	3,8	225	4960	145	32	388	18,2	5,8	144	6710	TRBM1720063	TRBM1120063	
*200	90	134	95	550	11,9	5,4	227	4900	125	38	388	18,2	8,2	163	6680	TRBM1720090	TRBM1120090	
*200	110	134	103	560	11,9	6,6	245	5110	120	40	388	18,2	10	160	6940	TRBM17200110	TRBM11200110	
*200	125	134	110	550	11,9	7,4	240	5060	115	43	388	18,2	11,4	165	6920	TRBM17200125	TRBM11200125	
*200	160	134	114	550	11,9	9,5	265	6150	98	53	388	18,2	14,6	178	8180	TRBM17200160	TRBM11200160	
*225	75	120	75	451	13,4	4,5	226	4630	120	75	451	20,5	6,8	227	6560	TRBM1722575	TRBM1122575	
*225	90	120	79	450	13,4	5,4	224	4820	120	79	450	20,5	8,2	225	6620	TRBM1722590	TRBM1122590	
*225	110	120	86	449	13,4	6,6	226	4960	120	85	449	20,5	10	227	6520	TRBM17225110	TRBM11225110	
225	125	135	40	445	13,4	7,4	180	4190	135	40	456	20,5	11,4	178	6120	TRBM17225125	TRBM11225125	
*225	160	120	98	498	13,4	9,5	250	6130	101	98	498	20,5	14,6	247	8280	TRBM17225160	TRBM11225160	
*225	180	134	134	558	13,4	10,7	280	7100	135	135	558	20,5	16,4	280	9540	TRBM17225180	TRBM11225180	
250	110	135	38	455	14,8	6,6	197	5420	135	38	450	22,7	10	197	7700	TRBM17250110	TRBM11250110	
250	160	110	58	450	14,8	9,5	219	5620	110	58	458	22,7	14,6	213	8040	TRBM17250160	TRBM11250160	

* codolo lungo

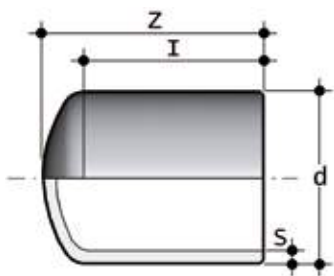

CBM

Calotta a codolo lungo per saldatura di testa

d	I	S	SDR 17,6 - S 8,3		I	S	SDR 11 - S 5		Codice SDR 17,6 - S 8,3	Codice SDR 11 - S 5
			Z	g			Z	g		
20	-	-	-	-	35	1,9	45	10	-	CBM11020
25	-	-	-	-	40	2,3	52	10	-	CBM11025
32	-	-	-	-	44	2,9	58	20	-	CBM11032
40	-	-	-	-	50	3,7	67	30	-	CBM11040
50	-	-	-	-	55	4,6	75	50	-	CBM11050
63	62	3,6	85	70	62	5,8	85	90	CBM17063	CBM11063
75	63	4,3	95	100	63	6,8	95	130	CBM17075	CBM11075
90	79	5,1	110	190	79	8,2	110	230	CBM17090	CBM11090
110	88	6,3	127	300	88	10,0	127	400	CBM17110	CBM11110
125	95	7,1	124	160	102	11,4	138	210	CBM17125	CBM11125
140	110	8,0	140	180	106	12,7	144	320	CBM17140	CBM11140
160	121	9,1	152	400	119	14,6	167	570	CBM17160	CBM11160
180	134	10,2	169	500	141	16,4	191	730	CBM17180	CBM11180
200	140	11,4	184	690	127	18,2	181	1060	CBM17200	CBM11200
225	160	12,8	200	960	141	20,5	211	1360	CBM17225	CBM11225
250	160	14,2	230	1500	152	22,7	230	3760	CBM17250	CBM11250
280	162	15,9	257	2100	162	25,4	257	5240	CBM17280	CBM11280
315	171	17,9	262	2900	180	28,6	262	6870	CBM17315	CBM11315
*355	-	-	-	-	63	32,2	124	6060	-	CBM11355
*400	-	-	-	-	72	36,3	132	8220	-	CBM11400

* codolo corto

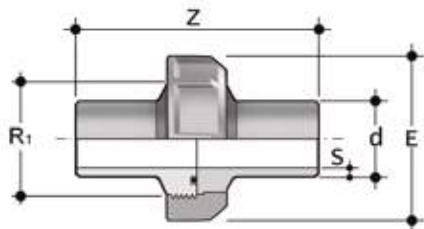

BBM-L

Bocchettone codolo lungo per saldatura di testa con guarnizione in EPDM o FPM

d	DN	R ₁	E	Z	SDR 11 - S 5 S	g	Codice EPDM	Codice FPM
20	15	1"	46	190	1,9	70	BBML11020E	BBML11020F
25	20	1" 1/4	56	190	2,3	105	BBML11025E	BBML11025F
32	25	1" 1/2	66	190	2,9	140	BBML11032E	BBML11032F
40	32	2"	79	190	3,7	210	BBML11040E	BBML11040F
50	40	2" 1/4	87	190	4,6	295	BBML11050E	BBML11050F
63	50	2" 3/4	107	190	5,8	480	BBML11063E	BBML11063F

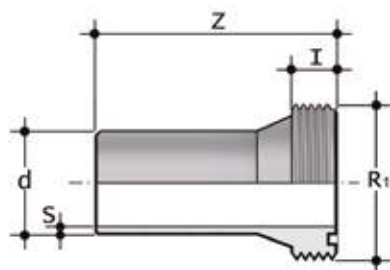

F/BBM-L

Pezzo fisso codolo lungo per saldatura di testa per bocchettone BBM-L

d	R ₁	I	SDR 11 - S 5 S	Z	g	Codice
20	1"	13	1,9	95	25	FBBML11020
25	1" 1/4	13	2,3	95	40	FBBML11025
32	1" 1/2	14	2,9	95	50	FBBML11032
40	2"	16	3,7	95	80	FBBML11040
50	2" 1/4	18	4,6	95	115	FBBML11050
63	2" 3/4	20	5,8	95	185	FBBML11063
75	3" 1/2	24	6,8	130	250	FBBML11075
90	4"	25	8,2	150	380	FBBML11090
110	5"	28	10	170	630	FBBML11110

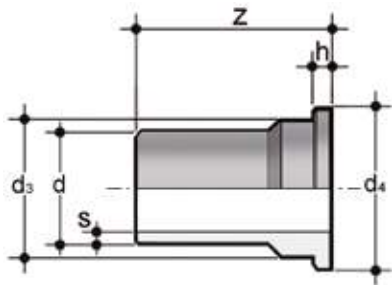

Q/BBM-L

Pezzo folle codolo lungo per saldatura di testa per bocchettone BBM-L

d	d ₃	d ₄	h	SDR 11 - S S	Z	g	Codice
20	25	29,6	5	1,9	95	20	QBBML11020
25	33	38,5	6	2,3	95	40	QBBML11025
32	39	44,2	6	2,9	95	45	QBBML11032
40	51	56	7	3,7	95	75	QBBML11040
50	57	62,2	7	4,6	95	110	QBBML11050
63	72	77,9	8	5,8	95	160	QBBML11063
75	83	96,7	9	6,8	130	290	QBBML11075
90	98	109,4	10	8,2	150	357	QBBML11090
110	118	134,8	11	10	170	630	QBBML11110

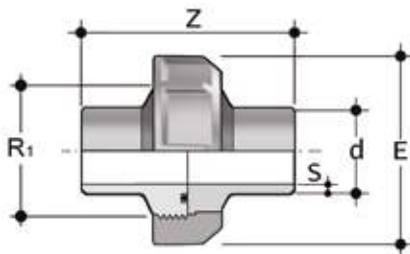

BBM-C

Bocchettone codolo corto per saldatura di testa con guarnizione in EPDM o FPM

d	DN	E	Z	S	g	Codice EPDM	Codice FPM
20	15	46	110	1,9	80	BBMC11020E	BBMC11020F
25	20	56	110	2,3	75	BBMC11025E	BBMC11025F
32	25	66	110	2,9	120	BBMC11032E	BBMC11032F
40	32	79	110	3,7	175	BBMC11040E	BBMC11040F
50	40	87	110	4,6	240	BBMC11050E	BBMC11050F
63	50	107	110	5,8	440	BBMC11063E	BBMC11063F

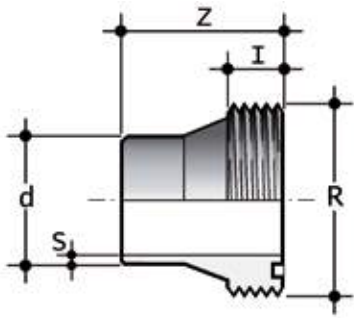

F/BBM-C

Pezzo fisso codolo corto per saldatura di testa per bocchettone BBM-C

d	R	l	Z	S	g	Codice
20	1"	13	55	1,9	20	FBBMC11020
25	1" 1/4	13	55	2,3	27	FBBMC11025
32	1" 1/2	14	55	2,9	40	FBBMC11032
40	2"	16	55	3,7	60	FBBMC11040
50	2 1/4"	18	55	4,6	86	FBBMC11050
63	2 3/4"	20	55	5,8	147	FBBMC11063
75	3 1/2"	24	55	6,8	200	FBBMC11075
90	4"	25	90	8,2	310	FBBMC11090
110	5"	28	90	10	600	FBBMC11110

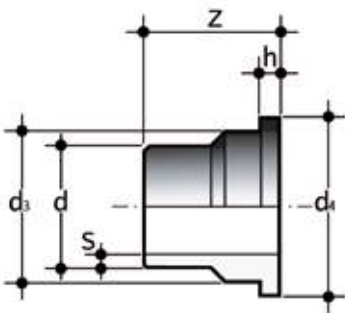

Q/BBM-C

Pezzo folle codolo corto per saldatura di testa per bocchettone BBM-C

d	d ₃	d ₄	h	Z	S	g	Codice
20	25	30	5	55	1,9	20	QBBMC11020
25	33,5	38,5	6	55	2,3	22	QBBMC11025
32	38	44,5	6	55	2,9	36	QBBMC11032
40	49,5	56,2	7	55	3,7	54	QBBMC11040
50	55	62,2	7	55	4,6	76	QBBMC11050
63	70	78,3	8	55	5,8	118	QBBMC11063
75	82,5	96,5	9	55	6,8	250	QBBMC11075
90	97,5	109,5	10	90	8,2	310	QBBMC11090
110	117,5	134,5	11	90	10	610	QBBMC11110

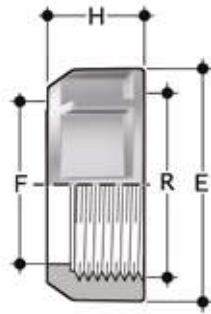

EFGM

Ghiera con filettatura cilindrica per bocchettoni BIGM, BIFGM, BIFOM, BIROM, BIFXM, BIRXM

R	d BIGM	PN	E	F	H	g	Codice
1"	20	10	47	28	22	19	EFGM100
1" 1/4	25	10	58	36	25	29	EFGM114
1" 1/2	32	10	65	42	27	40	EFGM112
2"	40	10	78	53	30	57	EFGM200
2" 1/4	50	10	85	59	33	74	EFGM214
2" 3/4	63	10	103	74	38	119	EFGM234

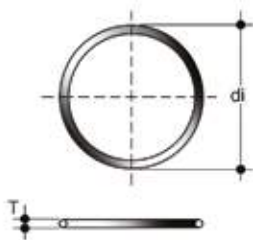

O-Ring

Guarnizione per bocchettoni tipo BIV, BIFV, BFV, BLV, BIRV, BIFOV, BIROV, BIFXV, BIRXV

d bocchettone	C	di	T	Codice EPDM	Codice FPM
16	3062	15,54	2,62	OR3062E	OR3062F
20	4081	20,22	3,53	OR4081E	OR4081F
25	4112	28,17	3,53	OR4112E	OR4112F
32	4131	32,93	3,53	OR4131E	OR4131F
40	6162	40,65	5,34	OR6162E	OR6162F
50	6187	47	5,34	OR6187E	OR6187F
63	6237	59,69	5,34	OR6237E	OR6237F
75	6300	75,57	5,34	OR6300E	OR6300F
90	6362	91,45	5,34	OR6362E	OR6362F
110	6450	113,67	5,34	OR6450E	OR6450F

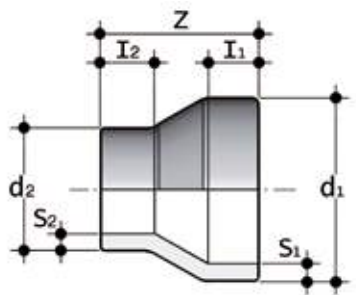

RBM

Riduzione concentrica codolo corto per saldatura di testa

d ₁	d ₂	l ₁	l ₂	Z	SDR 17,6 - S 8,3			SDR 11 - S 5			Codice SDR 17,6 - S 8,3	Codice SDR 11 - S 5
					s ₁	s ₂	g	s ₁	s ₂	g		
25	20	12	12	37	-	-	-	2,3	1,9	5	-	RBM11025020
32	20	12	12	43	-	-	-	2,9	1,9	8	-	RBM11032020
32	25	12	12	43	-	-	-	2,9	2,3	10	-	RBM11032025
40	20	12	12	50	2,3	1,9	9	3,7	1,9	13	RBM17040020	RBM11040020
40	25	12	12	50	2,3	2	10	3,7	2,3	15	RBM17040025	RBM11040025
40	32	12	12	50	2,3	2	11	3,7	3	18	RBM17040032	RBM11040032
50	25	12	12	55	2,9	2	10	4,6	2,3	23	RBM17050025	RBM11050025
50	32	12	12	55	2,9	2	17	4,6	3	25	RBM17050032	RBM11050032
50	40	12	12	55	2,9	2,3	20	4,6	3,7	29	RBM17050040	RBM11050040
63	32	16	12	65	3,6	2	32	5,8	3	43	RBM17063032	RBM11063032
63	40	16	12	65	3,6	2,3	36	5,8	3,7	50	RBM17063040	RBM11063040
63	50	16	12	65	3,6	2,9	38	5,8	4,6	55	RBM17063050	RBM11063050
75	32	19	12	80	4,3	2	55	6,8	3	70	RBM17075032	RBM11075032
75	40	19	12	71	4,3	2,3	50	6,8	3,7	71	RBM17075040	RBM11075040
75	50	19	12	71	4,3	2,9	54	6,8	4,6	79	RBM17075050	RBM11075050
75	63	19	16	71	4,3	3,6	60	6,8	5,8	89	RBM17075063	RBM11075063
90	50	22	12	80	5,1	2,9	86	8,2	4,6	125	RBM17090050	RBM11090050
90	63	22	16	80	5,1	3,6	82	8,2	5,8	129	RBM17090063	RBM11090063
90	75	22	19	80	5,1	4,3	102	8,2	6,9	155	RBM17090075	RBM11090075
110	50	28	12	105	6,3	2,9	100	10	4,6	150	RBM17110050	RBM11110050
110	63	28	16	97	6,3	3,6	100	10	5,8	200	RBM17110063	RBM11110063
110	75	28	19	97	6,3	4,3	90	10	6,9	160	RBM17110075	RBM11110075
110	90	28	22	97	6,3	5,1	160	10	8,2	140	RBM17110090	RBM11110090
125	63	30	16	112	7,1	3,6	120	11,4	5,8	180	RBM17125063	RBM11125063
125	75	32	19	108	7,1	4,3	130	11,4	6,9	200	RBM17125075	RBM11125075
125	90	32	22	108	7,1	5,1	130	11,4	8,2	200	RBM17125090	RBM11125090
125	110	32	28	108	7,1	6,3	150	11,4	10	220	RBM17125110	RBM11125110
140	75	35	19	123	8	4,3	160	12,7	6,9	240	RBM17140075	RBM11140075
140	90	35	22	115	8	5,1	170	12,7	8,2	260	RBM17140090	RBM11140090
140	110	35	28	115	8	6,3	140	12,7	10	210	RBM17140110	RBM11140110
140	125	35	32	115	8	7,1	150	12,7	11,4	220	RBM17140125	RBM11140125
160	90	40	22	135	9,1	5,1	400	14,6	8,2	700	RBM17160090	RBM11160090
160	110	40	28	124	9,1	6,3	350	14,6	10	430	RBM17160110	RBM11160110
160	125	40	32	124	9,1	7,1	400	14,6	11,4	700	RBM17160125	RBM11160125
160	140	40	35	124	9,1	8	250	14,6	12,8	370	RBM17160140	RBM11160140
180	90	45	22	157	10,2	5,1	600	16,4	8,2	660	RBM17180090	RBM11180090
180	110	45	28	157	10,2	6,3	630	16,4	10	900	RBM17180110	RBM11180110
180	125	45	32	136	10,2	7,1	370	16,4	11,4	510	RBM17180125	RBM11180125
180	140	45	35	136	10,2	8	510	16,4	12,8	610	RBM17180140	RBM11180140
180	160	45	40	136	10,2	9,1	500	16,4	14,6	700	RBM17180160	RBM11180160
200	140	50	35	154	11,4	8	750	18,2	12,8	730	RBM17200140	RBM11200140
200	160	50	40	151	11,4	9,1	670	18,2	14,6	700	RBM17200160	RBM11200160
200	180	50	45	151	11,4	10,2	920	18,2	16,4	1300	RBM17200180	RBM11200180

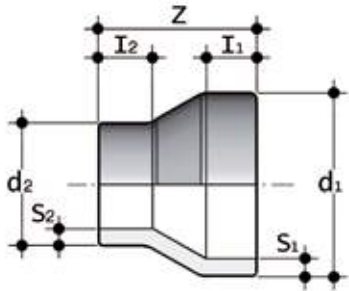

d ₁	d ₂	l ₁	l ₂	Z	SDR 17,6 - S 8,3			SDR 11 - S 5			Codice SDR 17,6 - S 8,3	Codice SDR 11 - S 5
					s ₁	s ₂	g	s ₁	s ₂	g		
225	140	60	50	160	12,8	8	1400	20,5	12,8	1800	RBM17225140	RBM11225140
225	160	55	40	171	12,8	9,1	700	20,5	14,6	960	RBM17225160	RBM11225160
225	180	55	45	171	12,8	10,2	580	20,5	16,4	1020	RBM17225180	RBM11225180
225	200	55	50	171	12,8	11,4	700	20,5	18,2	1200	RBM17225200	RBM11225200
250	160	60	40	194	14,2	9,1	880	22,7	14,6	1480	RBM17250160	RBM11250160
250	180	60	45	182	14,2	10,2	660	22,7	16,4	1200	RBM17250180	RBM11250180
250	200	60	50	182	14,2	11,4	730	22,7	18,2	1110	RBM17250200	RBM11250200
250	225	60	55	182	14,2	12,8	680	22,7	20,5	1040	RBM17250225	RBM11250225
280	200	85	70	200	15,9	11,4	2400	25,4	18,2	3600	RBM17280200	RBM11280200
280	225	85	72	200	15,9	12,8	2500	25,4	20,5	3700	RBM17280225	RBM11280225
280	250	85	80	200	15,9	14,2	2600	25,4	22,8	3800	RBM17280250	RBM11280250
315	200	95	85	230	17,9	11,4	3400	28,6	18,2	5100	RBM17315200	RBM11315200
315	225	95	88	230	17,9	12,8	3400	28,6	20,5	5200	RBM17315225	RBM11315225
315	250	95	95	230	17,9	14,2	3500	28,6	22,8	3500	RBM17315250	RBM11315250
315	280	95	107	230	17,9	15,9	3500	28,6	25,5	5400	RBM17315280	RBM11315280
355	200	57	40	160	20,1	11,4	3220	32,3	18,2	4400	RBM17355200	RBM11355200
355	225	57	40	140	20,1	12,8	3400	32,3	20,5	4390	RBM17355225	RBM11355225
355	250	54	40	130	20,1	14,2	2300	32,3	22,8	3560	RBM17355250	RBM11355250
355	280	53	40	120	20,1	15,9	1900	32,3	25,5	2950	RBM17355280	RBM11355280
355	315	53	40	110	20,1	17,9	1520	32,3	28,7	2170	RBM17355315	RBM11355315
400	225	64	40	160	22,7	12,8	5300	36,3	20,5	6300	RBM17400225	RBM11400225
400	250	61	40	150	22,7	14,2	4800	36,3	22,8	6000	RBM17400250	RBM11400250
400	280	60	40	140	22,7	15,9	4000	36,3	25,5	5800	RBM17400280	RBM11400280
400	315	50	40	120	22,7	17,9	3600	36,3	28,7	4800	RBM17400315	RBM11400315
400	355	51	40	110	22,7	20,1	3100	36,3	32,3	3400	RBM17400355	RBM11400355

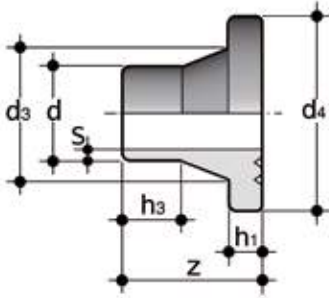

QBM

Collare d'appoggio codolo corto per saldatura di testa per flange libere ISO/DIN ODB

d	d ₃	d ₄	Z	SDR 17,6 - S 8,3				SDR 11 - S 5				Codice SDR 17,6 - S 8,3	Codice SDR 11 - S 5
				h ₁	h ₃	S	g	h ₁	h ₃	S	g		
20	27	45	50	-	-	-	-	7	30	1,9	15	-	QBM11020
25	33	58	50	-	-	-	-	9	26	2,3	30	-	QBM11025
32	40	68	50	-	-	-	-	10	25	2,9	45	-	QBM11032
40	50	78	50	11	24	2,3	60	11	24	3,7	66	QBM17040	QBM11040
50	61	88	50	12	23	2,9	77	12	21	4,6	87	QBM17050	QBM11050
63	75	102	50	14	18	3,6	115	14	16	5,8	129	QBM17063	QBM11063
75	89	122	50	16	35	4,3	180	16	14	6,8	200	QBM17075	QBM11075
90	105	138	80	17	43	5,1	280	17	33	8,2	322	QBM17090	QBM11090
110	125	158	80	18	37	6,3	365	18	27	10	430	QBM17110	QBM11110
125	132	158	80	18	42	7,1	390	25	35	11,4	490	QBM17125	QBM11125
140	155	188	80	18	34	8	530	25	27	12,7	715	QBM17140	QBM11140
160	175	212	80	18	34	9,1	660	25	27	14,6	915	QBM17160	QBM11160
180	182	212	80	20	30	10,2	610	30	50	16,4	890	QBM17180	QBM11180
200	232	268	100	24	36	11,4	1440	32	28	18,2	1900	QBM17200	QBM11200
225	235	268	100	24	46	12,8	1290	32	38	20,5	1780	QBM17225	QBM11225
250	285	320	100	25	35	14,2	2035	35	25	22,7	2865	QBM17250	QBM11250
280	291	320	100	25	45	15,9	1825	35	35	25,4	2600	QBM17280	QBM11280
315	335	370	100	25	35	17,9	2525	35	25	28,6	3500	QBM17315	QBM11315
355	373	430	120	30	30	21,1	3400	40	20	32,2	4720	QBM17355	QBM11355
400	427	482	120	33	42	23,7	4920	46	29	36,3	7320	QBM17400	QBM11400

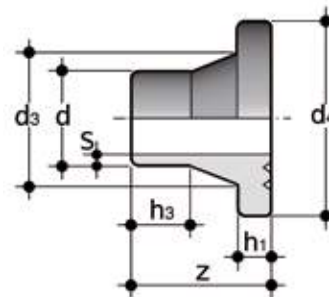

QBAM

Collare d'appoggio codolo corto per saldatura di testa, per flange libere ANSI B16.5 cl.150 OAB*

d	OAB size	d ₃	d ₄	Z	SDR 17,6 - S 8,3				SDR 11 - S 5				Codice SDR 17,6 - S 8,3	Codice SDR 11 - S 5
					h ₁	h ₃	S	g	h ₁	h ₃	S	g		
25	3/4"	33	54	50	-	-	-	-	9	26	2,3	30	-	QBAM11034
32	1"	40	63,5	50	-	-	-	-	10	25	2,9	45	-	QBAM11100
40	1" 1/4	50	72	50	11	24	2,3	60	11	24	3,7	66	QBAM17114	QBAM11114
50	1" 1/2	61	84,5	50	12	23	2,9	77	12	21	4,6	87	QBAM17112	QBAM11112
90	3"	105	132	80	17	43	5,1	280	17	33	8,2	322	QBAM17300	QBAM11300

* per altre dimensioni usare QBM

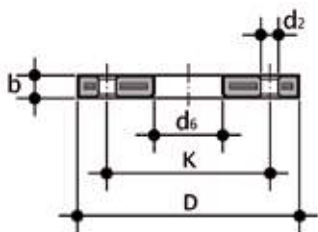

ODB

Flangia libera in acciaio rivestito in PP/FRP secondo EN/ISO/DIN per collari d'appoggio QBM. Foratura PN 10/16 fino a d180, PN 10 da d200 a d400

d	DN	*PMA (bar)	b	d ₂	d ₆	D	K	M	n	** (Nm)	g	Codice
20	15	16	12	14	28	95	65	M12	4	15	232	ODB020
25	20	16	14	14	34	105	75	M12	4	15	288	ODB025
32	25	16	14	14	42	115	85	M12	4	15	544	ODB032
40	32	16	16	18	51	140	100	M16	4	20	836	ODB040
50	40	16	16	18	62	150	110	M16	4	30	902	ODB050
63	50	16	19	18	78	165	125	M16	4	35	1074	ODB063
75	65	16	19	18	92	188	145	M16	4	40	1368	ODB075
90	80	16	21	18	109	200	160	M16	8	40	1516	ODB090
110	100	16	22	18	128	220	180	M16	8	40	1960	ODB110
125	100	16	22	18	134	220	180	M16	8	40	1938	ODB125
140	125	16	26	18	158	250	210	M16	8	50	2866	ODB140
160	150	16	27	22	178	285	240	M20	8	60	3576	ODB160
180	150	16	27	22	191	285	240	M20	8	60	3298	ODB180
200	200	16	28	22	235	340	295	M20	8	70	5032	ODB200
225	200	16	28	22	238	340	295	M20	8	70	4900	ODB225
250	250	16	31	22	288	395	350	M20	12	80	10182	ODB250
280	250	16	31	22	294	395	350	M20	12	80	9860	ODB280
315	300	16	34	22	338	445	400	M20	12	100	13150	ODB315
355	350	16	40	22	376	514	460	M20	16	160	22200	ODB355
400	400	16	40	26	430	571	515	M24	16	170	26214	ODB400

*PMA: pressione di esercizio massima ammissibile

**momento di serraggio nominale

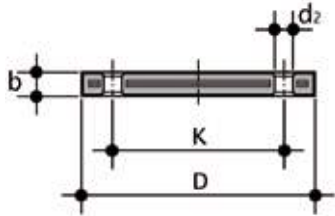

ODBC

Flangia cieca in acciaio rivestito in PP/FRP secondo EN/ISO/DIN.
Foratura PN 10/16 fino a d160/180, PN 10 da d200/225 a d400

d	DN	*PMA (bar)	b	d ₂	D	K	M	n	** (Nm)	g	Codice
20	15	16	12	14	95	65	M12	4	15	290	ODBC020
25	20	16	12	14	105	75	M12	4	15	390	ODBC025
32	25	16	16	14	115	85	M12	4	15	520	ODBC032
40	32	16	16	18	140	100	M16	4	25	800	ODBC040
50	40	16	16	18	150	110	M16	4	35	940	ODBC050
63	50	16	16	18	165	125	M16	4	35	1150	ODBC063
75	65	16	18	18	185	145	M16	4	40	1640	ODBC075
90	80	16	18	18	200	160	M16	8	40	1960	ODBC090
110/125	100	16	20	18	220	180	M16	8	45	2720	ODBC110
140	125	16	24	18	250	210	M16	8	50	3920	ODBC140
160/180	150	16	24	22	285	240	M20	8	60	5060	ODBC160
200/225	200	16	24	22	340	295	M20	8	70	7800	ODBC200
250/280	250	10	30	22	409	350	M20	12	100	15400	ODBC250
315	300	10	34	22	463	400	M20	12	110	26000	ODBC315
355	350	10	42	22	515	460	M20	16	160	39620	ODBC355
400	400	10	46	27	574	515	M24	16	170	50080	ODBC400

*PMA: pressione di esercizio massima ammissibile
**momento di serraggio nominale

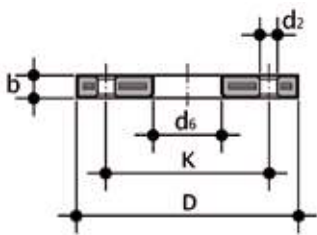

OAB

Flangia libera in acciaio rivestito in PP/FRP secondo ANSI B16.5 cl.150 per collari QBM e QBAM

Size	DN	*PMA (bar)	b	d ₂ mm	d ₂ inch	d ₆	D	K mm	K inch	n	** (Nm)	g	Codice
1/2"	15	16	12	16	5/8"	28	95	60,45	2" 3/8	4	15	200	OAB012
3/4"	20	16	12	16	5/8"	34	102	69,85	2" 3/4	4	15	240	OAB034
1"	25	16	16	16	5/8"	42	114	79,25	3" 1/8	4	15	490	OAB100
1" 1/4	32	16	16	16	5/8"	51	130	88,9	3" 1/2	4	25	670	OAB114
1" 1/2	40	16	18	16	5/8"	62	133	98,55	3" 7/8	4	35	640	OAB112
2"	50	16	18	20	3/4"	78	162	120,65	4" 3/4	4	35	1000	OAB200
2" 1/2	65	16	18	20	3/4"	92	184	139,7	5" 1/2	4	40	1310	OAB212
3"	80	16	18	20	3/4"	111	194	152,4	6"	4	40	1250	OAB300
4"	100	16	18	20	3/4"	133	229	190,5	7" 1/2	8	40	1660	OAB400
6"	150	16	24	22	7/8"	178	283	241,3	9" 1/2	8	60	3750	OAB600
8"	200	10	24	22	7/8"	236	345	298,45	11" 3/4	8	70	5140	OAB800
10"	250	10	27	25	1"	288	412	361,95	14" 1/4	12	100	8080	OAB810
12"	315	10	32	25	1"	338	487	431,8	17"	12	110	15380	OAB812
14"	355	10	42	28,5	1" 1/8	376	533	476,2	17" 3/4	12	110	24940	OAB814
16"	400	10	44	28,5	1" 1/8	430	596	539,7	18" 13/32	16	110	34770	OAB816

*PMA: pressione di esercizio massima ammissibile
**momento di serraggio nominale

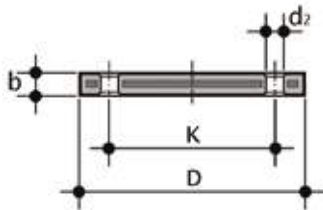

OABC

Flangia cieca in acciaio rivestito in PP/FRP secondo ANSI B16.5 cl.150

Size	DN	*PMA (bar)	b	d ₂ mm	d ₂ inch	D	K mm	K inch	n	** (Nm)	g	Codice
1/2"	15	16	12	16	5/8"	95	60,45	2" 3/8	4	15	200	OABC012
3/4"	20	16	12	16	5/8"	102	69,85	2" 3/4	4	15	240	OABC034
1"	25	16	16	16	5/8"	114	79,25	3" 1/8	4	15	370	OABC100
1" 1/4	32	16	16	16	5/8"	130	88,90	3" 1/2	4	25	530	OABC114
1" 1/2	40	16	18	16	5/8"	133	98,55	3" 7/8	4	35	560	OABC112
2"	50	16	18	20	3/4"	162	120,65	4" 3/4	4	35	810	OABC200
2" 1/2	65	16	18	20	3/4"	184	139,70	5" 1/2	4	40	1070	OABC212
3"	80	16	18	20	3/4"	194	152,40	6"	4	40	1030	OABC300
4"	100	16	18	20	3/4"	229	190,50	7" 1/2	8	40	1570	OABC400
6"	150	16	24	22	7/8"	283	241,30	9" 1/2	8	60	2400	OABC600
8"	200	16	24	22	7/8"	345	298,45	11" 3/4	8	70	3500	OABC800
10"	250	16	27	25	1"	412	361,95	14" 1/4	12	100	6200	OABC810
12"	300	16	32	25	1"	487	431,80	17"	12	110	13040	OABC812

*PMA: pressione di esercizio massima ammissibile
 **momento di serraggio nominale

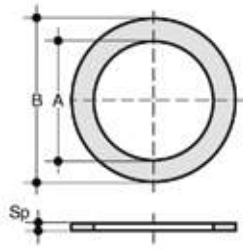

QHV/X

Guarnizione piana in EPDM e FPM per flangiatura secondo DIN 2501, EN 1092

d	DN	A	B	Sp	Codice EPDM	Codice FPM
20 - 1/2"	15	20	32	2	QHVX020E	QHVX020F
25 - 3/4"	20	24	38,5	2	QHVX025E	QHVX025F
32 - 1"	25	32	48	2	QHVX032E	QHVX032F
40 - 1" 1/4	32	40	59	2	QHVX040E	QHVX040F
50 - 1" 1/2	40	50	71	2	QHVX050E	QHVX050F
63 - 2"	50	63	88	2	QHVX063E	QHVX063F
75 - 2" 1/2	65	75	104	2	QHVX075E	QHVX075F
90 - 3"	80	90	123	2	QHVX090E	QHVX090F
110 - 4"	100	110	148	3	QHVX110E	QHVX110F

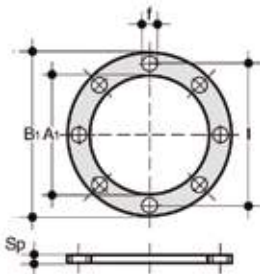

QHV/Y

Guarnizione piana in EPDM per flangiatura secondo DIN 2501, EN 1092, autocentrante per foratura PN 10/16

d	DN	A ₁	B ₁	f	I	U	Sp	Codice
20 - 1/2"	15	17	95	14	65	4	2	QHVY020E
25 - 3/4"	20	22	107	14	76,3	4	2	QHVY025E
32 - 1"	25	28	117	14	86,5	4	2	QHVY032E
40 - 1" 1/4	32	36	142,5	18	101	4	2	QHVY040E
50 - 1" 1/2	40	45	153,3	18	111	4	2	QHVY050E
63 - 2"	50	57	168	18	125,5	4	2	QHVY063E
75 - 2" 1/2	65	71	187,5	18	145,5	4	3	QHVY075E
90 - 3"	80	84	203	18	160	8	3	QHVY090E
110 - 4"	100	102	223	18	181	8	3	QHVY110E